

# Automated Squid Jigging and Prospects in Indian waters

Renjith, R. K., Jha, P. N., Chinnadurai, S., Remesan, M. P., Leela Edwin.  
ICAR-Central Institute of Fisheries Technology, Cochin

## Indian squid fisheries

Squid resource has emerged as one of the prime commodities in the export market. Most abundant and economically important squid species of Indian waters are *Lologoduvaceli*, *Loliolusuyii*, *Uroteuthisedulis*, *Loliolushardwickei*, *Sepioteuthislessoniana*, *Sthenoteuthisoualaniensis* and *Thysanoteuthis rhombus*. These priced resources are exploited from four marine states such as Gujarat, Maharashtra, Kerala and Tamil Nadu contributing about 3% of total marine fish production in India (CMFRI, 2017). They are being landed as bycatch of trawl fishery except for very few places. Targeted fishery of squid and other cephalopods are practised in a very limited extent, including hand-jig operation from catamartan at Vizhinjam (Nair, 1985) and plank built boats at Palk Bay (Lipton, 1990) hand-line with multiple hooklike 'Achil' of Kanyakumari and Trivandrum (Lazarus, 1984; Joel & Ebenezer, 1987), locally made jigs operated from Tuticorin (Balasubramanian *et al.*, 1995) and Japanese made hand-jigs of Keelakkarai, Devipattanam and Palk Bay of Tamil Nadu (Venkatesan & Shanmugavel, 2008), light assisted motorized boat fishing of Ratnagiri, Maharashtra (Sundaram & Sawant, 2013, 2014), FAD (Fish Aggregation Device) assisted aggregation and hand jigging of Karnataka (Sasikumar *et al.*, 2006). Structural changes from late 90's till now are limited to motorization alone, limiting the area of operation to 30-35m depth from shore. Since lining and jigging fetch extremely fresh catch, value of the commodity is very high and targeted fishery is being operated in stability. In contrast to the trawling operation, these methods are highly selective and bring larger squids.



Existing demand for the commodity encourages fishermen to exploit distant waters for capturing squid but also resulted in aimed trawling for squids and other cephalopods.

## Automated squid jigging

Squid jigging works on natural behavior of squid to rise into surface during night. Many researchers reviewed current theories of light attraction especially in marine organisms. It is summarised that squids show positive phototaxis, responds to light and colour with conditioned or unconditioned response where light is associated with food. Large scale fisheries using jigging exist at United States, Taiwan Province of China and New Zealand and Mexico of Pacific Ocean (Arkhipkin *et al.*, 2000). This method of fishing yield high value product as there is less damage to the squid. Commercial squid jigging is believed to be started in the Sado Island in the 19<sup>th</sup> century. Today, the design has developed from a manually operated rod to automated reels and high illuminated light sources. At the beginning, there was one jig per line but now it has given way for multiple jigs per line. In 1950's, jigger was equipped with wooden drums with a line of 10-40 jigs operated by artisanal sector. Automatic jigging machines were introduced later in 1960's, and the catch increased subsequently. The electric machines enabled the lines to descent up to 200m depth and also in easy retrieval (Inada & Ogura, 1988).

## Operation

Commercial squid jigging of the world can be classified into three types, namely coastal, off shore and large scale (Makino, 2011). The first deploys vessels of less than 30 gross tons (GT), second type uses 30-100 GT and the third

use vessels over 100 GT. The vessels were equipped with jiggling machine, lights and sea anchor. Jiggling machines are equipped at both sides. Generally Japanese jigging vessels have 20 or more mechanical jiggers.

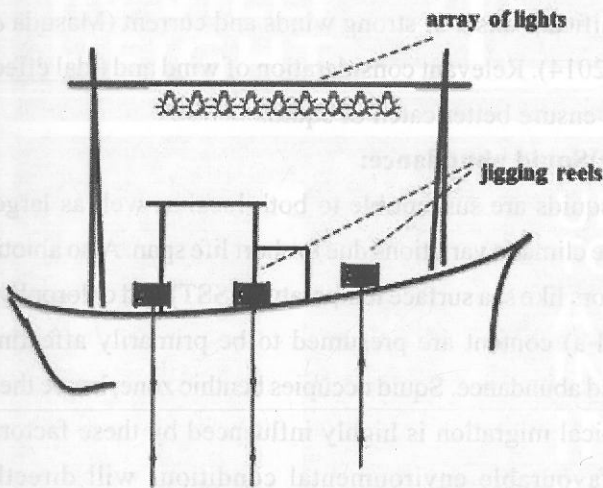
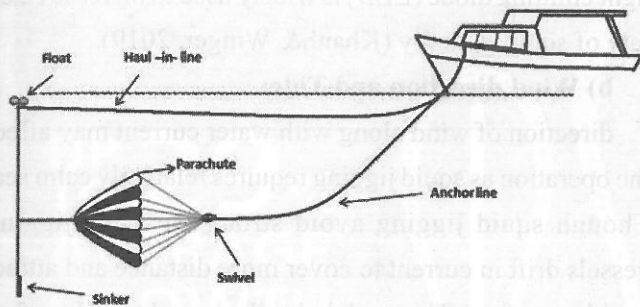

Fig. 1 Sea anchor

Modern squid jigging vessels have three basic accessories. A) Sea anchor B) Array of lights C) Jiggling machines

The sea anchor is a large parachute deployed into sea which can hold the vessel still in the water. These can be deployed off the bow or one side. It is kept steady in the water with the help of a sinker and float along with bridle using additional warp. Size of sea anchor depends on the size of boat. In large vessels, the structure may have 20-30 feet diameter.

The vessels use array of incandescent lights to attract squids at night, and some may use underwater lights

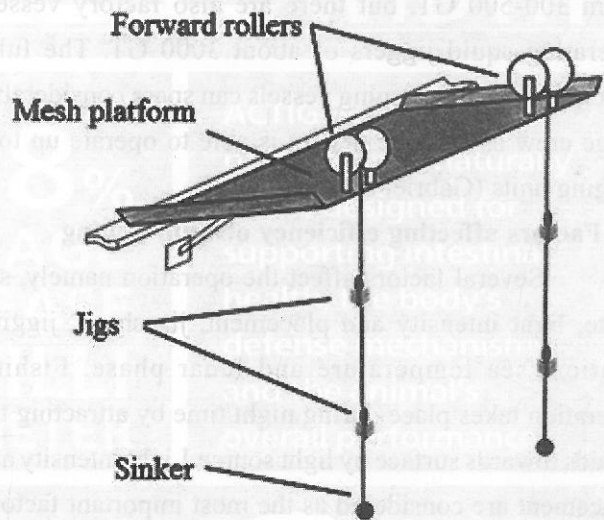
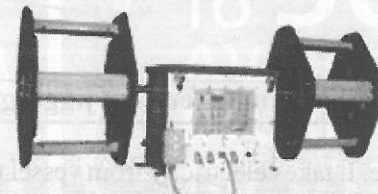
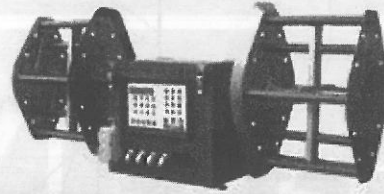
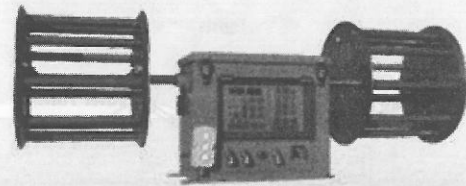
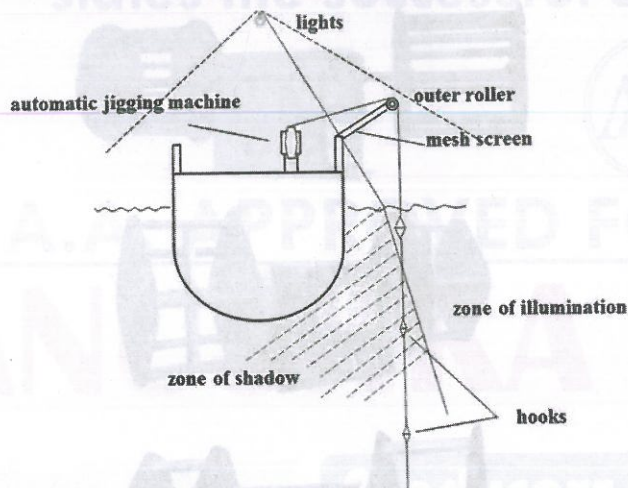

Fig. 2 Array of lights

also. The light arrangement can be lowered and hauled slowly to concentrate schools near to surface. The manual squid jigging is performed by hand-driven rollers which drops the jig. Later with mechanization, automated rollers used for lowering the jigs to about 30-140 m. The line is lowered to the desired depth by unwinding the reel. The machine makes jerking movements during retrieval of line facilitated by oval or elliptical shape of reel.

The jigging machines have separate winding mechanism which does not consume power from shaft of



**Fig. 5 General arrangement for jigging operation**

vessel engine. It takes electricity from vessel to illuminate lights. A squid jigger operates from vessels of size ranging from 300-500 GT, but there are also factory vessels operating squid jiggers of about 3000 GT. The fully mechanized squid jigging vessels can spare considerably large crew as a single person is able to operate up to 5 jigging units (Gabriel *et al.*, 2008).

#### **Factors affecting efficiency of squid jigging**

Several factors affect the operation namely, sea state, light intensity and placement, jig shape, jigging motion, sea temperature and lunar phase. Fishing operation takes place during night time by attracting the squids towards surface by light source. Light intensity and placement are considered as the most important factors. High light intensity attracts squids towards the jigger but too much light may reduce catch significantly. Major factors that affects squid aggregation are

##### **a) Lunar phase and light intensity:**

Lunar phase has pronounced effect on squid jigging. When moon is full, less squids will be attracted by artificial light and hence darkest nights can expect good catch of squid. In other words, catch will decrease when the moon appears after midnight. Generally squid jigging boats operate just before sunset and till sunrise. Fishermen turn on all lights at the beginning to attract the dispersed squid to surface water and keep minimum lights

afterwards. This is practised because squid seems to avoid strong light and remains at shadow zone (Ogura & Myokaku, 1972). Though light attraction in squid is evident, intensity and colour of light has varying effect on different species (Ibrahim & Hajisamae, 1999). Today, light emitting diode (LED) is widely used to increase catch rate of squid globally (Khanh & Winger, 2019).

##### **b) Wind direction and Tide:**

direction of wind along with water current may affect the operation as squid jigging requires relatively calm sea. Though squid jigging avoid strong currents, jigging vessels drift in current to cover more distance and attract squid to surface. This trick helps the vessel to reduce fuel consumption and shifting ground. But catch will reduce significant onset of strong winds and current (Masuda *et al.*, 2014). Relevant consideration of wind and tidal effect will ensure better catch of squid.

##### **c) Squid abundance:**

squids are susceptible to both local as well as large-scale climatic variations due to short life span. Also abiotic factors like sea surface temperature (SST) and chlorophyll (Chl-a) content are presumed to be primarily affecting squid abundance. Squid occupies benthic zone, hence their vertical migration is highly influenced by these factors. Unfavourable environmental conditions will directly affect squid aggregation. Some studies revealed that sea surface salinity (SSS) and sea level anomaly (SLA) also plays important role in squid abundance. Different age-groups of squid tend to occupy different depth of ocean hence sea depth (bathymetry) data is relevant in predicting size of squid in shoal (Arkhipkin *et al.*, 2000).

##### **d) Presence of other animals:**

Squid fishery has frequent report of interaction with other animal especially marine mammals, birds and turtles. Principal food item of sperm whale is squid (Roeo, 1969). Hence the chance of preying by sperm whale on squid accidentally leads to ingestion of jigs. Natural instinct of predatory animals is to attack anything that moves. Mostly marine mammals are fast swimmers and also

located near fishing vessels to collect fishes, chance of interaction with fishing gear is certain. When visually attractive jig is pulled through the water column in rhythmic pattern, accidental hooking by other organism is expected. Many authors reported sperm whale interaction in many parts of the world.

#### Status of automated squid jigging in Indian waters

Few occurrences of automatic squid jigging are noted along Indian coast mostly by Fishery Survey of India at the end of 1980's. Fishery Survey of India vessel *Matsya Sugundhi* conducted jigging for neritic squids between latitudes 8° N and 17° N in the depth range 25-200 m and for the oceanic squids between latitudes 10° N-14° N in area beyond 500 m depth. Based on the FSI report, the fish catch was about 96,213 kg using 823 hauls. There are many places along the coast of India where hand jigging is practised minimally. The fishery is seasonal and species specific (Sundaram & Deshmukh, 2011).

Biological investigations on *Stenotheuthis oualaniensis* pointed out for developing a new commercial distant water squid jigging fishery. Government fisheries institutions such as Central Marine Fisheries Research Institute and Central Institute of Fisheries Nautical Engineering and Training have conducted experimental fishing in the Indian EEZ (Exclusive Economic Zone) for quantifying squid abundance. From 2008 to 2013, a collaborative project by CMFRI, CIFT, NIFPHATT and FSI initiated conversion of trawler to squid jigger from Mangaluru (Mohamed *et al.*, 2014). The promising results from these operation initiated commercial light fishing ventures off Mangaluru and small-scale jigging with LED lights in southern Maharashtra and Goa (Sundaram & Sawant, 2014). Later, extensive use of light fishing in these regions leads to conflict between traditional sector and purse-seining sector of Goa and Karnataka. Following these agitations in November 2018, Government of India specifically banned fishing operations such as bull

trawling/pair trawling and prohibited using light for attracting/aggregating fishes. In connection with the ban on light fishing, Kerala Fishing Boat Operators Association has reported to approach High Court seeking direction from state and Central Government to start squid jigging in the Indian waters.

#### Conclusion

Global demand for cephalopods has been increasing in the recent times compared to early 90's. This creates demand for Indian squid mostly caught by trawl fishery. Since trawling is non-selective and causes indiscriminate catch of the resources whereas squid caught by jigging known to have superior quality and less impact to environment, demand will be more for the later. Considering the existing policy on light fishing, light assisted squid jigging need to go a long way to establish as a fishery. In this context, the responsible fishing of squid has to be emphasized where jigging is known to cause less impact on environment. With introduction of necessary facilities like light and mechanization of operation, squid jigging can be performed responsibly from Indian waters.

**Please send your valubale articles  
to the below address or send  
to our mail address**

**AQUASTAR**

**1st Floor, Flat No.A4,**

**Rithvika Towers, Y-Junction,**

**SKVT**

**Degree College Road,**

**Gandhipuram-1,**

**Rajamahendravaram -533101**

**E.G.Dt., A.P.**

**Cell: +91 98481 67720**

**e-mail: aquastar9@gmail.com,**

**gvbabu@aquastarmagazine.com**